

CALRAD

28 Series - Decora Wall Jacks

SOLDER AND SOLDERLESS DECORA INSERTS FOR AUDIO AND VIDEO

Calrad decora inserts provide a wide variety of configurations for most audio or video applications. We are now offering selected configurations with screw terminals for secure non-solderable wire connections. Connection points are labeled for easy wire identification allowing for easy installation and maintenance. We have also added both single and double HD DB15, DVI-I, HDMI feedthrus.

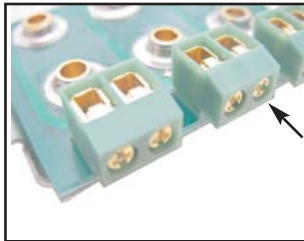

Phillips/Slotted Style Screws
Accepts up to 14 gauge cable

28-103-P GOLD PLATED 2 PAIR BANANA JACKS

Plastic insert plate. Recessed banana jacks with isolated terminal, with solderable leads. Insert color is white. Red/black terminals. Includes mounting hardware.

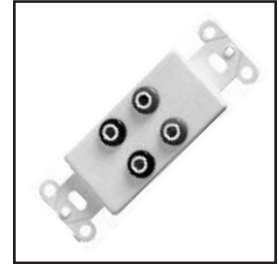

28-103-T New Item Screw Terminal Version

28-123 FOUR PAIR BANANA JACKS

Metal insert plate. Insert color is white. Red/black terminals. Includes mounting hardware.

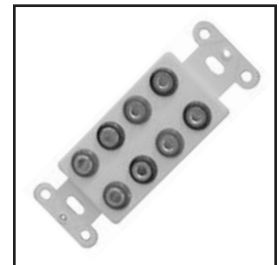

28-123-T New Item Screw Terminal Version

28-100-P GOLD PLATED 1 PAIR BINDING POSTS

Plastic insert plate. Standard 5 way binding posts, independently isolated terminals, with solderable leads. Insert color is white. Includes mounting hardware.

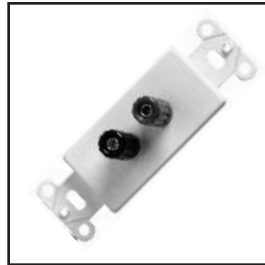

28-100-T New Item Screw Terminal Version

Accepts up to 14 gauge wire

28-124 GOLD PLATED FOUR PAIR FIVE-WAY BINDING POSTS

Metal insert plate. Insert color is white. Double standard 5 way binding posts. Independently isolated terminals, with solderable leads. Red & black binding posts. Includes mounting hardware.

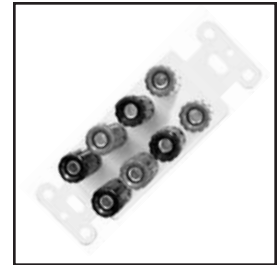

28-124-T New Item Screw Terminal Version

28-101-P GOLD PLATED 2 PAIR BINDING POSTS

Plastic insert plate. Double standard 5 way binding posts, independently isolated terminals, with solderable leads. Insert color is white. Red & black binding posts.



28-101-T New Item Screw Terminal Version

28-132 GOLD PLATED FIVE-WAY AUDIO SPLITTER

Connect 4 pairs of speakers to the terminal block, 1 pair to Decora style wall plate with gold binding posts. Removable terminal plugs for easy wiring. Power handling capacity is 75 watts. Rear terminal strips accept up to 16 awg. cable. Insert color is white. Red & black terminals.



28-102-P GOLD PLATED 1 PAIR BANANA JACKS

Plastic insert plate. Recessed banana jacks with isolated terminals and solderable leads. Insert color is white. Red/black terminals. Includes mounting hardware.

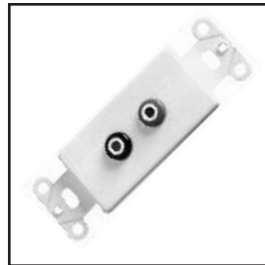

28-102-T New Item Screw Terminal Version

28-122 GOLD DECORA STYLE SPEAKER BINDING POSTS

WHITE IVORY

- | | |
|-----------------|--------------------|
| 28-122-2 1 Pair | 28-122-IV-2 1 Pair |
| 28-122-4 2 Pair | 28-122-IV-4 2 Pair |
| 28-122-6 3 Pair | 28-122-IV-6 3 Pair |
| 28-122-8 4 Pair | 28-122-IV-8 4 Pair |

Perfect for single channel outputs (L+R), A+B (L+R) or 5.1, 7.1 surround sound speaker distribution. Solderless wire termination. Works with single or dual male banana plugs or binding post termination. Accepts up to 14 AWG cable. Available in 1, 2 or 4 channel configurations. Easy color coded speaker polarity markings (red/black) Available in white or ivory, please specify color when ordering.

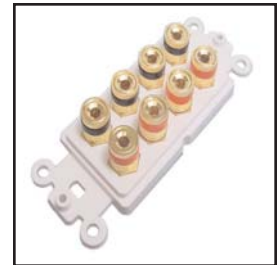

28 Series - Decora Wall Jacks

28-104-P GOLD PLATED SINGLE RCA JACK

Plastic insert plate. Standard black RCA type jack with solderable leads. Insert color is white. Includes mounting hardware.

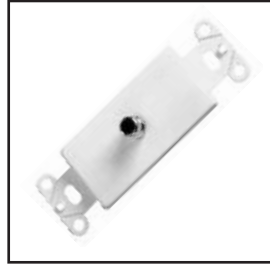

28-104-T New Item Screw Terminal Version

28-117-P 1/4" INCH GOLD PLATED STEREO JACK

Plastic insert plate. Insert color is white. Solderable leads. Includes mounting hardware.

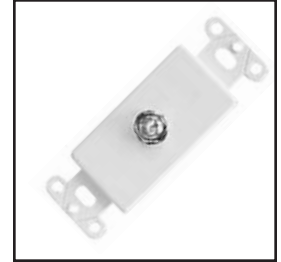

28-105-P GOLD PLATED DOUBLE RCA JACKS

Plastic insert plate. Standard red/white RCA type jacks with solderable leads. Insert color is white. Includes mounting hardware.

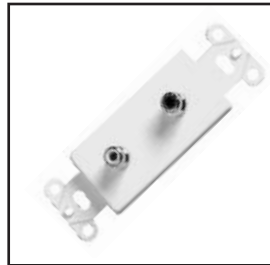

28-105-T New Item Screw Terminal Version

28-109-P SINGLE COAX JACK 28-110-P DOUBLE COAX JACKS 28-111-P TRIPLE COAX JACKS

Gold Plated Feed-thru F connectors on a plastic decora style plate. Available in either 1, 2 or 3 connectors. Insert color is white. Includes mounting hardware.

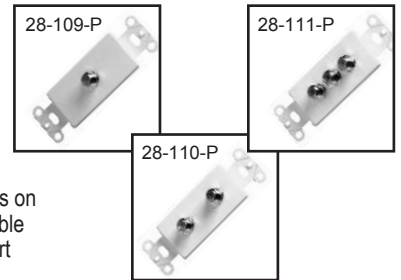

28-106-P GOLD PLATED TRIPLE RCA JACKS

Plastic insert plate. Standard yellow red/white RCA type jacks with solderable leads. Insert color is white. Includes mounting hardware.

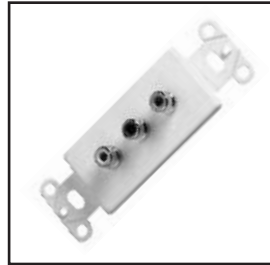

28-106-T New Item Screw Terminal Version

28-118 GOLD PLATED XLR MALE

Plastic insert plate. Insert color is white. Solderable leads. Includes mounting hardware.



28-107-P GOLD PLATED DOUBLE RCA JACKS WITH SINGLE COAX

Plastic insert plate. Solderable red/white RCA jacks, feed-thru F connector. Insert color is white. Includes mounting hardware.



28-107-T New Item Screw Terminal Version

28-119 GOLD PLATED XLR FEMALE

Plastic insert plate. Insert color is white. Solderable leads. Includes mounting hardware.

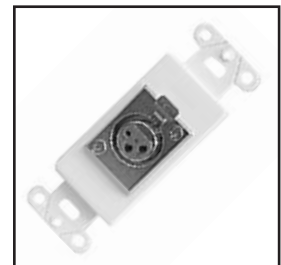

28-108-P GOLD PLATED TRIPLE RCA JACKS WITH SINGLE COAX

Plastic insert plate. Solderable yellow red/white RCA jacks, feed-thru F connector. Insert color is white. Includes mounting hardware.

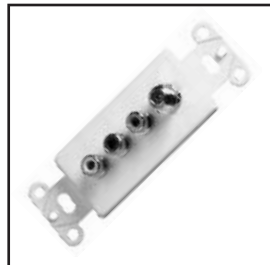

28-108-T Screw Terminal Version

28-125 SINGLE 50 OHM GOLD PLATED BNC FEMALE JACK

28-126 DUAL 50 OHM GOLD PLATED BNC FEMALE JACKS

Gold Plated BNC jacks in a plastic insert plate. Color is white. Solderable leads. Includes mounting hardware.

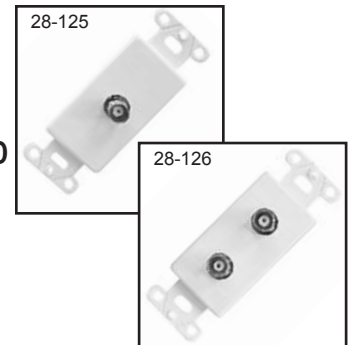

CALRAD

28 Series - Decora Wall Jacks

28-127 TWO RCA JACKS AND ONE FEMALE BNC JACK, GOLD PLATED

White metal insert plate. Solderable leads, includes mounting hardware

28-127-T New Item Screw Terminal Version

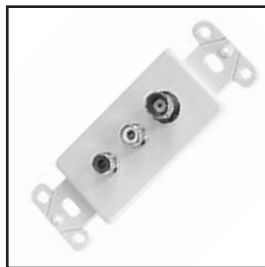

28-131 A-B SELECTOR FOR AMPLIFIER OR SPEAKER SWITCHING WITH ISOLATED GROUNDS

Plastic insert plate fits into single gang standard electrical junction box. Removable screw to connect terminal blocks. Accepts up to 14 awg. wire. Power handling of 55 watts per channel/max. Isolated ground terminals for amplifier protection. Easy to read terminal identification. Break before make switching.



NEW
IMPROVED
DESIGN

28-120 STEREO A+B SPEAKER SWITCH

White plastic insert plate. Power rating is 50 watts. Common ground switching. Includes mounting hardware.

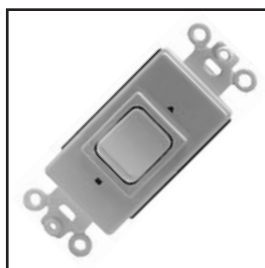

28-150g gold New Item 28-150 nickel DUAL RCA JACKS AND ONE FEMALE SVHS JACK

White plastic decora insert plate with one SVHS video and L+R, red/white audio feed thru jacks. Comes in either Gold or Nickel plated versions. Includes mounting hardware.

28-150-T New Item Screw Terminal Version

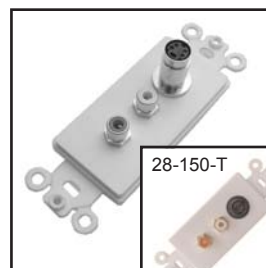

28-128 HEADPHONE JACK AND SPEAKER SWITCH

White plastic insert plate. Push switch and 1/4" Stereo headphone jack. 100 watts cont. / 150 watts peak. Includes mounting hardware.



28-151 4 pin Version, Gold Plated 28-153 6 pin Version, Nickel Plated 4 OR 6 PIN MINI DIN SINGLE FEED THRU JACK

White plastic insert plate. Mini Din feed thru jack. Includes mounting hardware.

DUAL VERSION 28-152 4 Pin Version, Gold Plated 28-154 6 Pin Version, Nickel Plated



28-129 A/B OR A+B SPEAKER SWITCH

White plastic insert plate. Rotary type switch. Screw-to-connect terminal blocks. 100 watts cont. / 150 watts peak. Includes mounting hardware.



28-165 COMPONENT RGB VIDEO RCA FEED-THRU JACKS

White plastic insert plate. Red, Green, Blue feed-thru female to female jacks with colored inserts. Nickel body connectors. Includes mounting hardware



HDTV

28-130 SPEAKER SELECTOR FOR 2 PAIRS OF SPEAKERS

White plastic insert plate. Push type switch. Screw-to-connect terminal blocks. 100 watts cont. / 150 watts peak. Common ground switching. Includes mounting hardware.



28-170 HDTV - RGB VIDEO BNC FEED-THRU JACKS

White plastic insert plate. True 75 ohm BNC female to female feed-thru jacks with eye-catching colored plastic washers for easy RGB identification. Nickel body connectors. Includes mounting hardware.



HDTV

CALRAD

28 Series - Decora Wall Jacks

HDTV

28-160 SINGLE HIGH DENSITY DB-15 FEED-THRU AND DUAL RCA FEED- THRU JACKS

White plastic insert plate. HD-DB-15 high density female to female jack with red/white RCA female to female jacks. Includes mounting hardware.

28-160.....nickel

28-160G.....gold



HDTV

28-166 Single Version 28-167 Dual Version HDMI TO HDMI FEED-THRU

White plastic decora insert plate with single or dual HDMI female to female feedthru. Comes with red LED signal indicator. Nickel plated. Includes mounting hardware. Color is white.

New Item

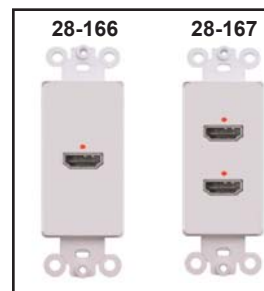

28-166

28-167

28-161 SINGLE HIGH DENSITY DB-15 FEED-THRU

White plastic decora insert with a single HD-DB-15 feed-thru jack. Available in nickel or gold plated versions. Includes mounting hardware.

28-161.....nickel

28-161G.....gold



HDTV

28-190 BLANK KEYSTONE CUTOUT WITH TWO 3/8" HOLES

White plastic decora blank insert, with 1 - blank keystone, 2 - Hex nut cutouts for .375" connectors. Hex nut size = .445"

New Item



28-162 DUAL HIGH DENSITY DB-15 FEED-THRU

White plastic decora insert plate. 2 HD-DB-15 high density female to female jacks. Comes in either nickel or gold versions. Includes mounting hardware.

28-162.....nickel

28-162G.....gold



HDTV

28-114-P BLANK INSERT

White plastic insert plate. Insert used as a blank or can be drilled or punched to fit various jacks, connectors, etc. Includes mounting hardware.

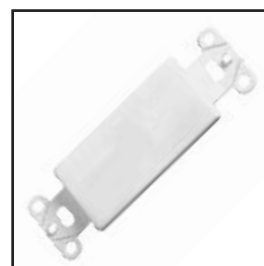

28-163 DVI-I TO DVI-I FEED-THRU

White plastic decora insert plate with one DVI-I female to female feedthru. Nickel plated. Includes mounting hardware. Color is white



HDTV

SINGLE GANG PLATES

28-112

WHITE STEEL WALL PLATE

28-113

WHITE PLASTIC WALL PLATE

28-113-IV

IVORY PLASTIC WALL PLATE



New Item

28-164-M Single DVI-I feed thru 28-164G Single Gold DVI-I feed thru 28-164-M-2 Dual DVI-I feed thru DVI-I FEED-THRU

Stainless Steel full sized wall plate with either a single or dual DVI-I female to female feed-thru. Can only be mounted in a wall bracket style fixture and not a standard "J" box, due to extended length of rear connection (see photo). Use Calrad part number

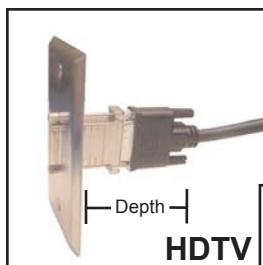

HDTV

DOUBLE AND TRIPLE GANG WALL PLATES

28-115-P.....double

28-116-Ptriple
(Plastic), color: white.

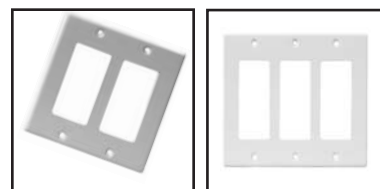

Wall Bracket Mount Only, Use Calrad 70-558, 70-559, 70-553, 70-568 and 70-569, see page 119.



DVI-I Pinout



CALRAD

28 Series - Decora Inserts, Blank Hex Hole, Attenuator Covers, Keystone Inserts

New Item

28-180 HEX HOLE DECORA INSERTS

White and Ivory plastic insert plates available in 1, 2, 3, 6, and 8 hole configurations. Will accept any 3/8" audio & video connectors, RCA, RF, etc. Works with Calrad 30 and 75 Series 3/8" feed-thru connectors. **Please Specify hole number and color version when ordering**

Hex cutout = .445"

Colors: White or Ivory

WHITE

28-180-1.....1 hole	28-180-1-IV.....1 hole
28-180-2.....2 holes	28-180-2-IV.....2 holes
28-180-3.....3 holes	28-180-3-IV.....3 holes
28-180-4.....4 holes	28-180-4-IV.....4 holes
28-180-6.....6 holes	28-180-6-IV.....6 holes
28-180-8.....8 holes	28-180-8-IV.....8 holes

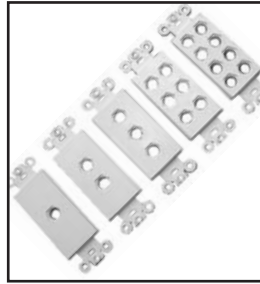

IVORY

New Item

28-145 COLORED DECORA COVERS FOR CALRAD AUDIO ATTENUATORS

These decora inserts are designed to be used with Calrad 25-360 & 25-361 attenuators. Easy to remove insert comes with matching knob. Provides the installer or end user the ability to match most decor colors.

28-145-AL.....Almond
28-145-BK.....Black
28-145-IV.....Ivory
28-145-W.....White

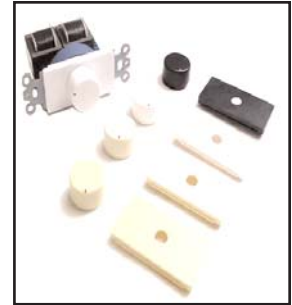

New Item

A/V WIRE DISTRIBUTION SINGLE GANG WALL PLATE

Angled exit wall plate allows for inwall cables to be routed downwards

Hole Dimensions: 1.44" X .35"

28-181-IV.....Ivory
28-181-WH.....White



New Item

RECESSED CAT5 DECORA INSERTS

Calrad's new CAT5 decora inserts offer the perfect solution to projecting wall connectors. Recessed to give a smooth, flush-faced appearance, these inserts come in a variety of designer colors for easy identification (ie. RGB). Available options include **RCA, BNC, SVHS, 3.5mm Stereo, RJ11 & RJ45, Toslink, Banana Jacks, USB Type A and Type B, 4 & 6 Pin Firewire, F-81**. These snap-in feedthru jacks are perfect for the home installer who wants a clean and easy way to terminate wall outlets and for the discriminating customer who desires an esthetic answer to protruding wall connectors.

PLEASE NOTE COLOR ABBREVIATIONS:
BLACK = BK
BLUE = BU
GREEN = GN
ORANGE = OR
RED = RD
WHITE = WH
YELLOW = YL

RCA Feedthru

72-308G-Color.....Gold
72-308-Color.....Nickel

BNC Feedthru

72-307-Color.....75 Ohm
72-210-Color.....50 Ohm

SVHS Feedthru

72-304G-Color.....Gold
72-304-Color.....Nickel

4 & 6 Pin Firewire Feedthru & Solderless 4 Pin

72-120K.....Feedthru
72-120K-S.....Solderless

USB Type "A" & "B" Feedthru & Solderless Type "A"

72-125K.....Feedthru
72-125K-S.....Solderless

3.5mm Stereo Feedthru

72-310-Color.....Nickel

F-81 RF Feedthru

72-342-BU.....2Ghz
72-341-RD.....1Ghz

Banana Jack Feedthru

72-330-BK.....Black
72-330-RD.....Red

6 Pin

72-122K.....Feedthru
72-122K-S.....Solderless

Type "B"

72-126K.....Feedthru
72-126K-S.....Solderless

Toslink Feedthru

72-320-Color

RJ45 Feedthru

72-305

RJ12 Feedthru

72-306

